



Perfect on-site supply

Intelligent concepts for on-site
gas production



Contents:

- 3 Industrial gases
- 4|5 Purity and quantity as required
- 6|7 Cryogenic air separation
- 8|9 Non-cryogenic air separation
- 10 Hydrogen production
- 11 Step by step to an on-site supply



Industrial gases: as important as water and electricity

There is a virtually unlimited supply of nitrogen, oxygen and argon because of their natural occurrence within the atmosphere. These gases, along with the rare noble gases present in air, can be obtained through special separation processes. Any components from this separation process that are not required are simply returned to the atmosphere.

Every gas has its special “qualities”:

Today, air gases and hydrogen are as natural a requirement for industrial processes as water and electricity. Oxygen, for example, is used in steel refining, and is also essential in the glass industry as well as in environmental technology. The properties of nitrogen are used for inerting in chemical, petrochemical and pharmaceutical processes, among others. Argon, a noble gas obtained from air, plays a central role in the production of stainless steel and is also used as a purge gas in semiconductor manufacture.

Hydrogen is used in annealing high-alloy steels and sintered parts as well as oxide reduction of molten metal. It is also used as an efficient fuel in glass polishing.

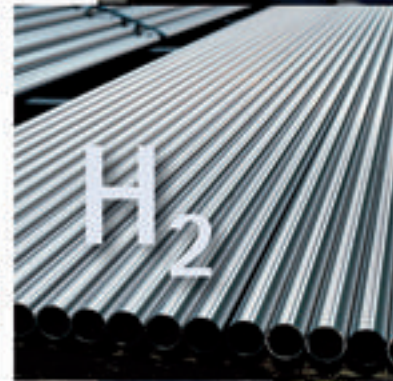



Air separation unit at Messer in Hungary

Purity and quantity as required

On-site gas production facilities make sense wherever there is a constantly high demand for industrial gases. An on-site unit facilitates a cost-optimised and reliable supply, which is made even more secure through the use of backup systems and Messer logistics.

The volume and purity required varies from sector to sector and also depends on the process applications that are used. Messer therefore offers its customers a supply concept that is precisely tailored to individual requirements.

There are basically two air separation methods: cryogenic and non-cryogenic.

Cryogenic air separation

In cryogenic air separation units, the gases present in the air are separated according to the low-temperature rectification principle, making use of the gases' differing boiling temperatures. In addition to the two main components, nitrogen and oxygen, it is possible to obtain pure form argon as well as the rare noble gases krypton and xenon.

The cryogenic separation principle is used in the following types of units:

- Multi-product high capacity air separation units with optional liquefaction
- CryoGAN nitrogen generators
- CryoGOX oxygen generators

Constituent	Chemical symbol	% by volume
Nitrogen	N ₂	78.08
Oxygen	O ₂	20.95
Argon	Ar	0.93
Carbon dioxide	CO ₂	0.035
Hydrogen	H ₂	5 · 10 ⁻³
Neon	Ne	1.82 · 10 ⁻³
Helium	He	5.2 · 10 ⁻⁴
Krypton	Kr	1.14 · 10 ⁻⁴
Xenon	Xe	8.7 · 10 ⁻⁶

The composition of air



Messer offers air separation units, based on cryogenic and non-cryogenic separation processes, with the following nominal capacities:

Type of unit	Product	Nominal capacity	
		Nm ³ /h	t/day
Air separator	O ₂	750 - 60,000+	25 - 2,000+
	N ₂ , Ar	up to 180,000	
Generators	O ₂	2,500 - 12,000	85 - 410
	N ₂	200 - 5,000	6 - 150
PSA	N ₂	10 - 5,000	0.3 - 150
PSA/PSA	O ₂	100 - 5,000	3.4 - 170
Membrane	N ₂	10 - 3,500	0.3 - 105

Non-cryogenic air separation

Non-cryogenic air separation processes work on the pressure swing adsorption principle or are based on separation by means of semipermeable membranes. The following types of units are well established:

- Pressure swing adsorption (PSA)
- Vacuum pressure swing adsorption (VPSA)
- Membrane units

Which type of unit is "best"?

It is necessary though to determine requirements in terms of gas purity, gas quantity and demand profile. An initial selection as to the appropriate type of unit can be made on the basis of the two diagrams below.



PSA unit for the production of nitrogen

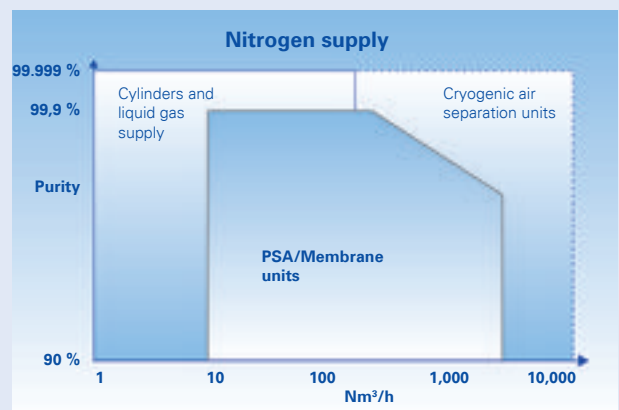
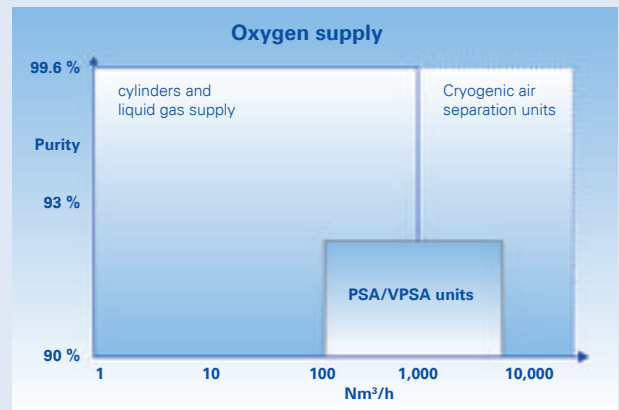

Cryogenic air separation units ensure a flexible and reliable supply

Air separators

For industries that either consume large quantities of industrial gases (steel, petrochemicals, refining) or require a multi-product supply (oxygen, nitrogen and argon), the gases are usually supplied via an air separation unit (ASU).

With this type of unit, air is first compressed to around 6 bar. After the removal of unwanted components – mainly carbon dioxide and humidity – in a molecular sieve, the air is passed into heat exchangers where it is cooled until it liquefies. This is followed by rectificatory separation into the individual components, which are then evaporated in a countercurrent to the incoming flows and reheated to near-ambient temperature.

A further option is the production of liquid products by means of additional cooling using expansion turbines.

Technology that meets your requirements

Messer offers a reliable and varied range of cryogenic air separation units, providing maximum flexibility from 25 to more than 2,000 metric tonnes per day (in terms of oxygen capacity).

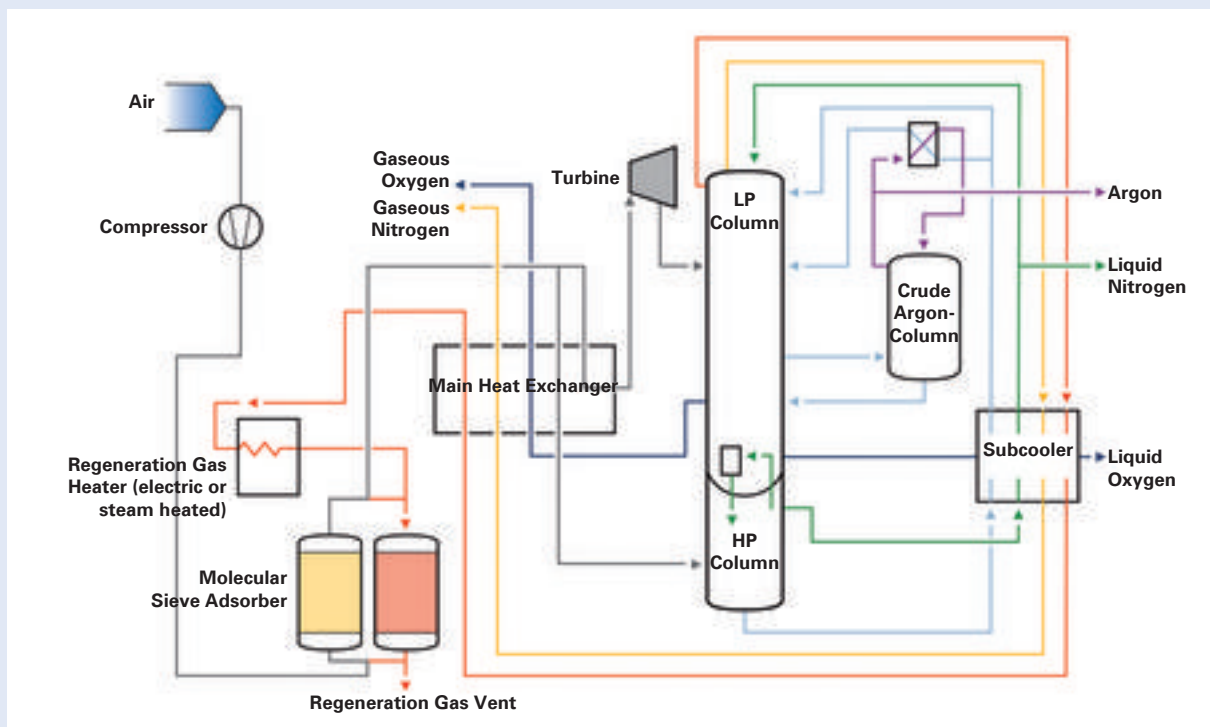

Flow diagram of an air separation unit



Even our so-called **standard packages** possess all the advantages from our technical experience in innovative plant design combined with short delivery times and low costs. Where an **individually designed plant** is the right solution, our team of experts will ensure that every customer requirement relating to product specifications, pressure, flow rate or flexibility is fulfilled to the highest possible standard.

Messer is also the right partner for **high purity gas facilities**. Our HIGH PURITY air separation units have flexible capacity at purity levels of 99.995% for oxygen and in the ppb range for nitrogen and argon.

Also available are **liquefiers** for a 100% liquid supply, which Messer builds with capacities of up to 600 metric tonnes a day.

CryoGAN nitrogen generators – a particularly cost-effective solution

Nitrogen (N₂) is known for its protective qualities, which is why it is often used in inerting and shielding applications where an oxygen-free atmosphere is required. Medium-sized consumers often use N₂ as a “utility gas”, which is supplied in liquid form. The focus is on a particularly cost-effective supply.

In order to meet the demand for larger quantities of nitrogen at low costs, Messer has developed the CryoGAN generator. This is a special nitrogen production unit that operates on the principle of cryogenic air separation.

Messer develops and builds the CryoGAN generators in-house. The units are modular in design and offer a graduated capacity range from 200 Nm³/h to 5,000 Nm³/h.

CryoGOX oxygen generators – compressed air and compressed costs

With CryoGOX oxygen generators, Messer has developed a cost-effective, reliable, flexible and uncomplicated oxygen supply. They are in demand from a variety of industries (pulp and paper, glass, ceramics, chemicals and metallurgy).

These generators, too, are based on the principle of cryogenic air separation, albeit with internal product compression: the liquid oxygen is extracted from the low pressure column and pumped through the heat exchangers under pressure in order to cool the incoming air gases. The resulting stream of gaseous oxygen is available to customers at pressures of up to 20 bar. The main advantages of this concept are the non-requirement of an expensive oxygen compressor, high oxygen purity (99.6%) and the capability of cost-effective liquid nitrogen production for stockpiling.

CryoGOX oxygen generators are built by Messer according to customer specifications. Capacities from 85 to 400 metric tonnes a day cover most industrial applications.

How the customer benefits from cryogenic air separation

- High oxygen purity
- Very reliable operation
- Low energy consumption
- Parallel production of liquid oxygen and liquid nitrogen

Non-cryogenic air separation units for practically every requirement

Messer offers a portfolio of non-cryogenic technologies for every conceivable application and customer process.

PSA units – air is all you need

The PSA (Pressure Swing Adsorption) process is based on the physical adsorption properties of specially treated molecular sieves. PSA units only need clean, dry air in order to generate N₂ or O₂ cost-effectively and with purities of up to 99.9% (nitrogen) and 93% (oxygen). This air is compressed up to 10 bar, purified and then passed through vessels filled with the molecular sieve, either carbon molecular sieves (CMS) or zeolites, depending on the type of gas required (O₂ or N₂).

A continuous nitrogen or oxygen supply is achieved by switching the gas stream: while one vessel is in operation, the other is regenerated by reducing the pressure. The unwanted gas components are released into the atmosphere.

VPSA units – oxygen production can be this cost-effective

The VPSA (Vacuum Pressure Swing Adsorption) process represents a modification of the PSA process. VPSA units have a fan which generates an overpressure of around 1.5 bar, and a vacuum pump, which is used during the regeneration cycle. This leads to a reduction in energy consumption.



Membrane unit

Membrane units – nitrogen at the touch of a button

The membrane process makes use of the different rates at which air gases diffuse through a polymer membrane. Atmospheric air is filtered, compressed to the required pressure, dried and then passed through a membrane module. The air components with the higher rate of diffusion (O₂ and CO₂) penetrate the polymer membrane fibres more quickly, resulting in a nitrogen-rich flow as the primary product. The purity of the N₂ gas flow depends on the flow rate through the membrane module, reaching 93.0 – 99.5% and more if operated efficiently.

Reliable backup supply

A secure supply from a backup source – just in case it is ever needed – is the icing on the cake of any on-site concept, allowing the consumer to sleep easy with regard to the gas supply, even when there are maintenance downtimes, power cuts or other unforeseeable events. Our regional logistics network with centrally managed Europe-wide coordination, combined with sophisticated production planning, ensures that every single customer receives a reliable supply of technical gases from Messer, even during planned and unplanned downtimes.



Backup system



How the customer benefits from non-cryogenic air separation

- Low costs – thanks to low energy consumption
- Reliability – selected components from well-known manufacturers and regular maintenance are essential for reliable plant operations
- Nitrogen/oxygen as required – quick start-up and uncomplicated operation enable the customer to use gas as an operational utility
- Modular units – transportable and low space requirement
- Safety – through low operating temperatures

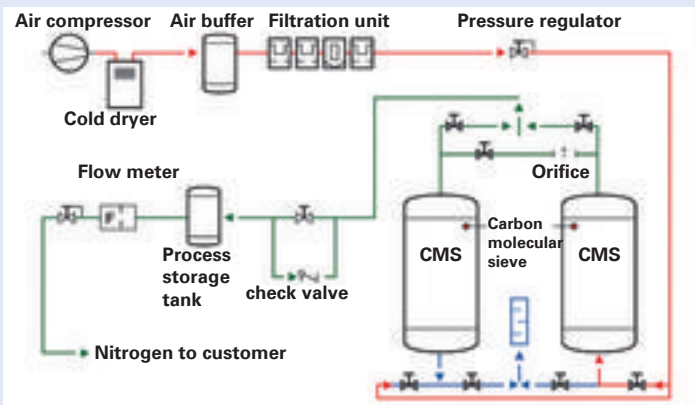

Flow diagram for a PSA unit

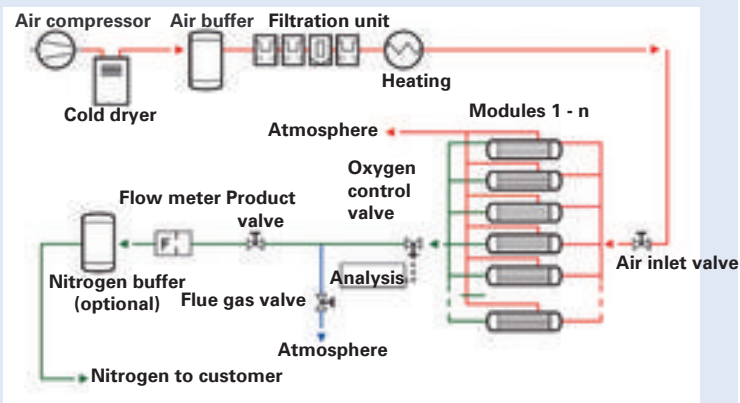

Flow diagram for a nitrogen membrane unit

Shared advantages: flexibility and economy

All the non-cryogenic processes presented here – PSA, VPSA and Membrane – are very flexible in terms of their application. In addition, they offer great potential in terms of economy, which is maximised through the advice and support provided by the Messer specialists, based on the stipulated purity and the required throughput.



Hydrogen production – as individual as its users

Messer offers a whole range of technologies for the production of hydrogen and Syngas, with the choice of the optimum process depending on several factors. These include the application, volume requirement and purity. The experts from Messer will be happy to advise you on this.

Electrolysis, steam reformer or PSA – a question of the starting point

For smaller hydrogen consumers or customers who do not have an alternative source material on site, Messer offers **electrolysis units** for hydrogen production with a capacity of 0.5 to 100 Nm³/h. These units, individually designed by Messer, are modular in design, offering maximum flexibility when it comes to planning or expansion. Hydrogen purities of 99.9% and above can be achieved, thereby satisfying even the high purity standards of the food, electronics and chemical industries.

Steam reformers use natural gas as a feedstock and can be used for both small and large hydrogen units. With the so-called steam reforming process, the feedstock is mixed with process steam, heated to approximately 480°C and then split in the reformer using a nickel-based catalyst. In the CO Shift Reactor, in which carbon monoxide (CO) reacts with H₂O to form H₂ and CO₂ (catalytic conversion), the hydrogen content in the reformed gas increases further.



Hydrogen unit, 2,000 Nm³/h

After this, the hydrogen-rich gas is cooled in several stages and condensate is separated. Finally, the hydrogen is purified in a multi-bed PSA unit. It leaves the PSA unit under 15 to 30 bar of pressure and with a purity of up to 99.9995%.

For companies that already have a hydrogen supply but require higher purities for downstream use, Messer can supply **hydrogen PSA units** as separate units. They receive the hydrogen-rich gas flow and convert it into high purity hydrogen (>99.999%).

The hydrogen PSA unit can be integrated into the customer's existing setup and operates fully automatically, with the number of adsorption beds (tanks) depending on the H₂ throughput. The hydrogen product is available with constant flow, pressure and temperature values.

Hydrogen production through steam reforming

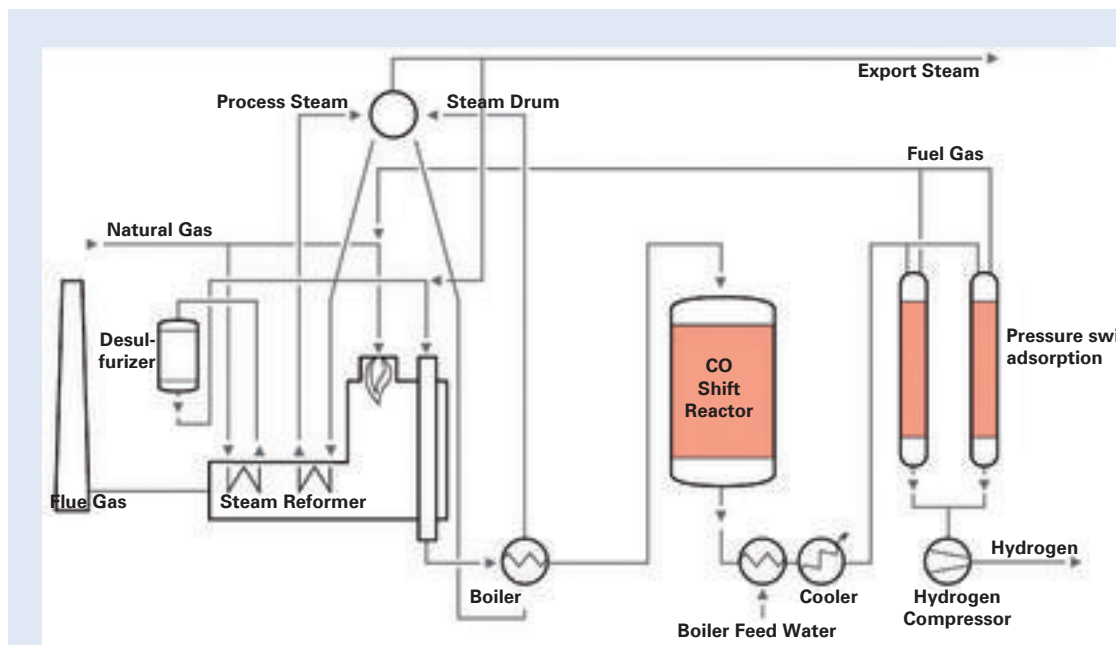

Step by step to an on-site supply

Technical gas supply requirements essentially depend on the industry and applications in question. Against this background, Messer has developed a "priority ranking list" to facilitate project planning for an on-site supply in order to be able to offer supply concepts that precisely meet each customer's requirements in terms of gas type, quantity and quality:

1. The customer's technology process
2. Process parameters, including type of gas, pressure, purity, degree of automation, operating times, consumption profiles
3. Initial assessment/feasibility of project in terms of gas production technology, energy consumption, gas costs, backup facilities, safety considerations
4. Computer-based process modelling for simulation of technical concepts
5. Reliability analysis, ensuring efficient, uninterrupted operating times
6. Preparation and submission of tender for the supply concept
7. Completion/acceptance of supply concept
8. Installation and start-up of unit

Our aim is to develop a supply concept tailored to your individual needs

Messer's aim in the area of on-site supply is clearly defined: on or next to the customer's site, we operate units that are optimised to meet the particular gas requirements of each customer. This means that the customer can use the required gases just as easily as electricity from the grid. Such a supply is based on an appropriate supply contract for technical gases. Alternatively, the customer can acquire an on-site unit and operate it on his own. It is also possible to sign an operational management contract with Messer. The sale of the units is handled through Cryogenic Engineering, a company that was set up as a joint venture between the German company, Messer Group GmbH, and the Chinese manufacturer of air separation units, Hangzhou Hangyang Co. Ltd.

Operating conditions and safety monitored at all times

While large air separators are manned by their own operating teams, a fully automated, unmanned solution is often feasible for smaller units. Messer has set up the European Control Center (ECC) in Budapest for the purpose of operating and monitoring such units. It is connected with every single unit via a data transmission system, facilitating round-the-clock monitoring of the most important operating data and any alert notifications. In the event of abnormal operation of one of the units, the ECC arranges for Messer staff to resolve the problem on-site within a very short time.

PSA unit for hydrogen production



All the units are remotely monitored from the Control Center in Budapest.



A strong background

Messer Group GmbH is one of the leading industrial gases companies in Europe and China. The company operates air separation units for bulk production and for supplying large industrial consumers from the steel, chemical and petrochemical industries. Liquid oxygen, nitrogen and argon are some of the products in greatest demand.

Messer has over 100 years of experience in the design and operation of air separation units and is constantly strengthening its lead in expertise. The units that are built and operated by Messer are regarded worldwide as state-of-the-art in terms of design, build quality and reliability.

Messer is active in 30 countries in Europe and Asia, as well as Peru, with more than 60 operating companies. Its international activities are managed from Frankfurt am Main, with the core technical functions – logistics, engineering, production and technology management – managed from Krefeld.



MESSER 
Gases for Life

Messer Group GmbH
Gahlingspfad 31
47803 Krefeld
Tel. +49 2151 7811-0
Fax +49 2151 7811-501
info@messergroup.com
www.messergroup.com

Part of the Messer World 